

A 1 **B 1**

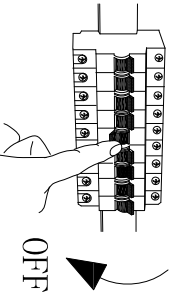

A 2 **B 2**

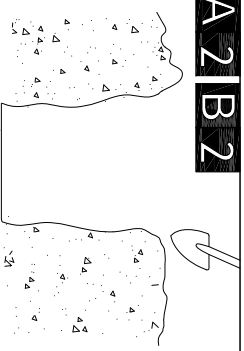

1). Setzen Sie die Leuchte erst in ein ca. 15cm hohes Sandbett ein.
2). Füllen Sie danach das restlich ausgehobene Loch mit beton aus.

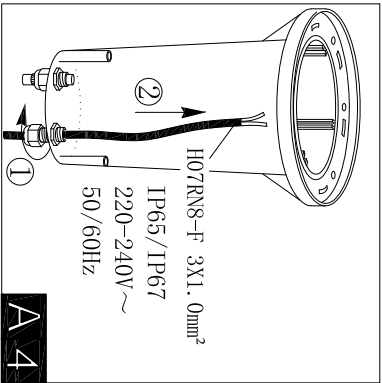
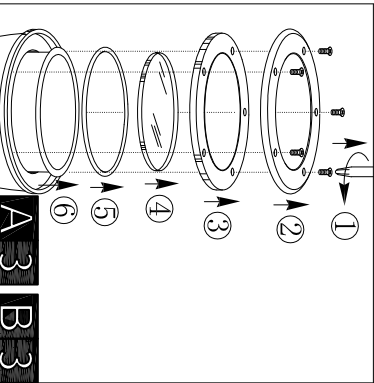

A 5

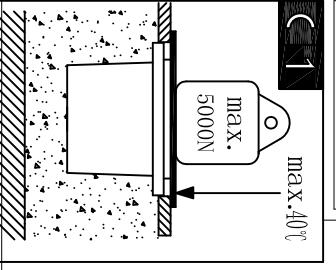
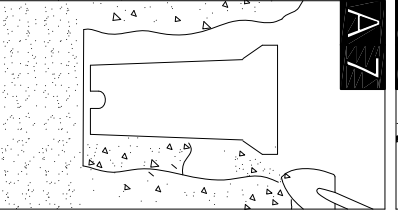
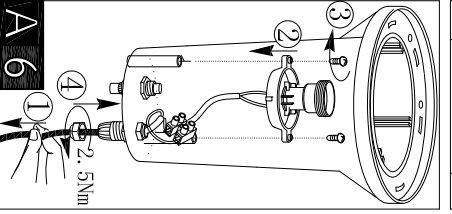
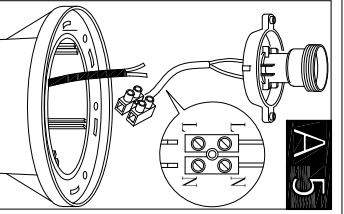

B 4

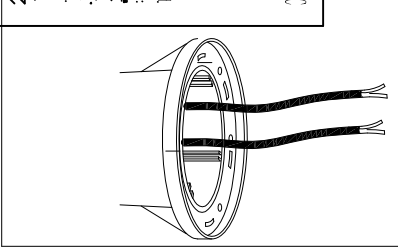
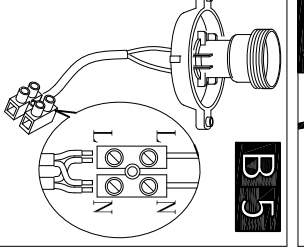
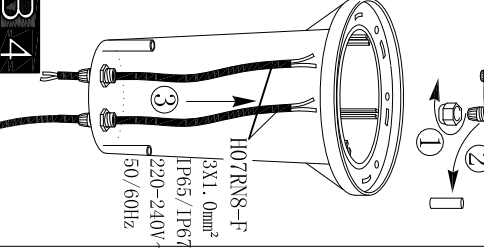
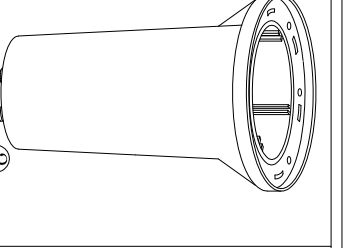

IPX7

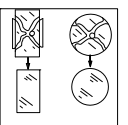
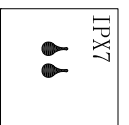

±5mm

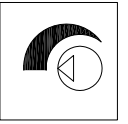
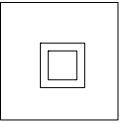

EXCL. E27

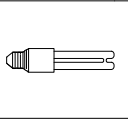
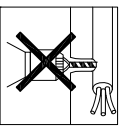
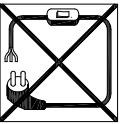
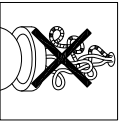
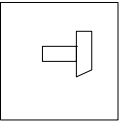

A

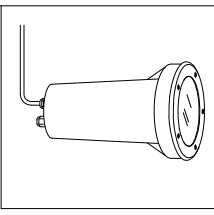

B

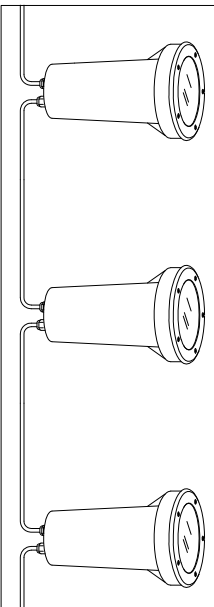

A 8 **B 8**

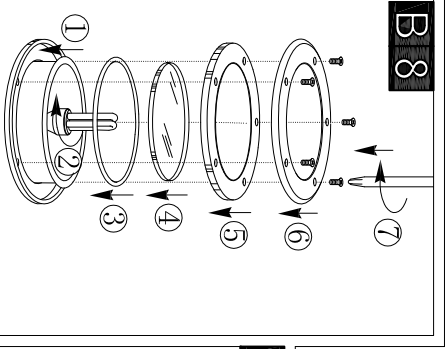

A 9 **B 9**

